

2007



Ersatzteil-Katalog

Die meist verkauften FIAMMA Ersatzteile

Spare Parts Catalogue

FIAMMA Best Selling Spare Parts

Liste Pièces Détachées

Les pièces détachées FIAMMA les plus demandées

Catalogo Ricambi

I ricambi FIAMMA più richiesti

fiamma.com

N. 202 Rel. 3.0.0 Jan/2007













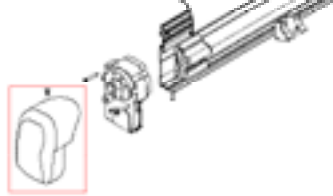

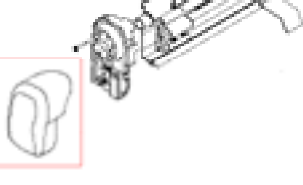

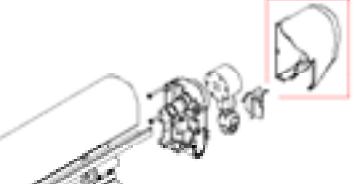

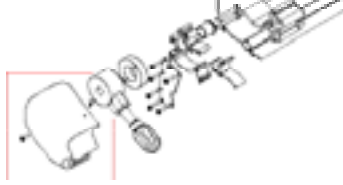

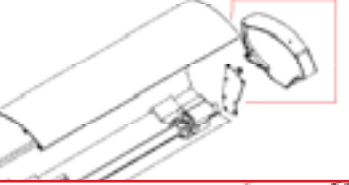

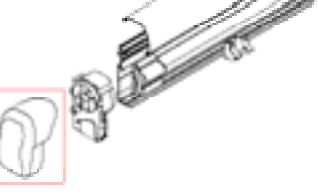





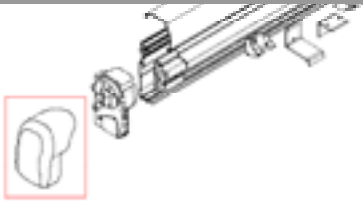

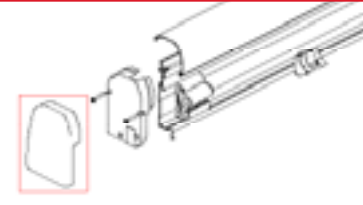

Fiamma SpA - Milano Airport Highway

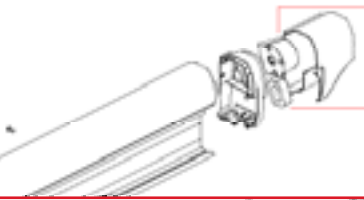

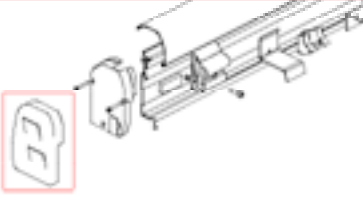

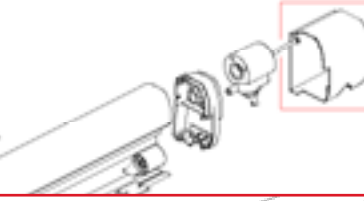

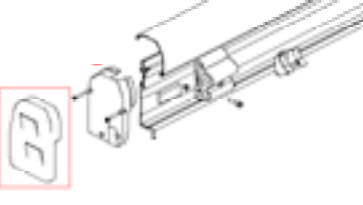





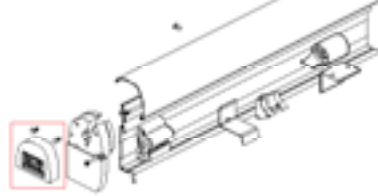

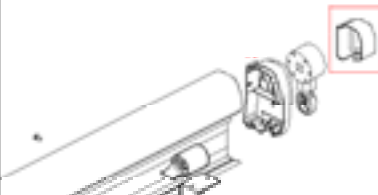

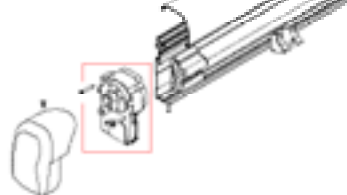
69, V. Europa - 21010 Cardano al Campo - ITALY



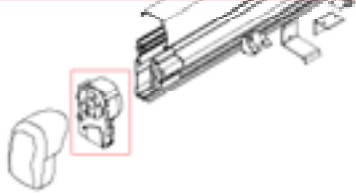

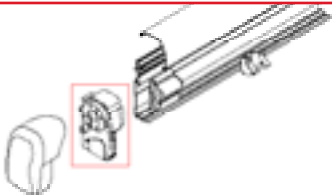

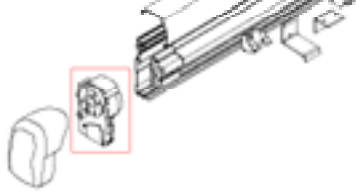

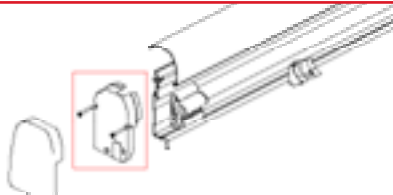



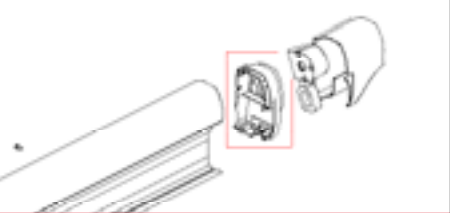

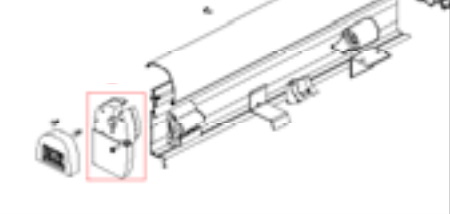

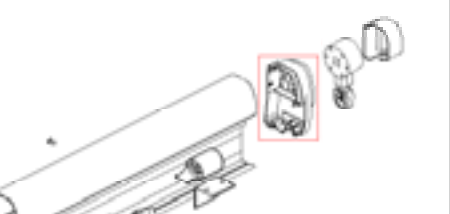
Fax +39 0331730940

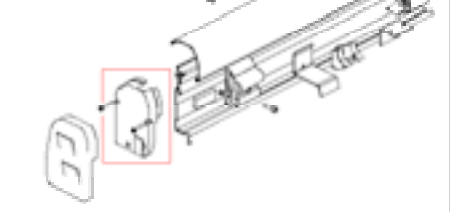



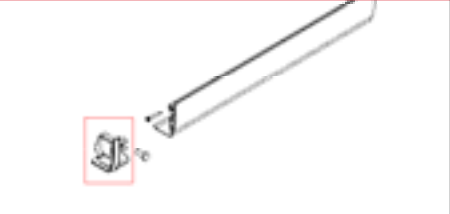



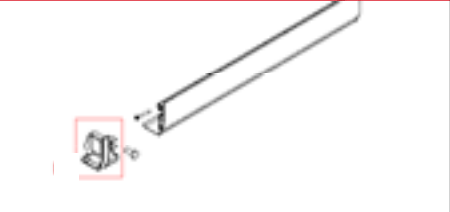





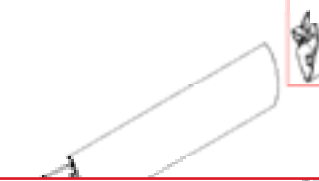

fiamma.com
service@fiamma.it



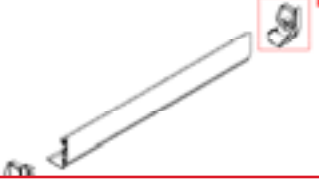











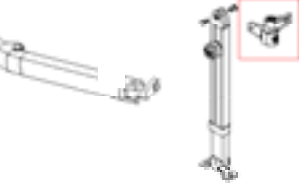

	Nummer/Beschreibung Code/Description - Code/Description - Codice/Descrizione	Für - For Pour - Per	
	<p>98655-014 Linke Abdeckkappe - <i>LH End Cover</i> - Cache de protection gauche - <i>Cuffia cassonetto Sx</i> Dim./Maße: 140x85x80 mm</p>	<ul style="list-style-type: none"> • F45i • ZIP 250 300 350 • F1 POLAR WHITE 	
	<p>04274-01C Rechte Abdeckkappe - <i>RH End Cover</i> - Cache de protection droit - <i>Cuffia cassonetto Dx</i> Dim./Maße: 140x85x80 mm</p>	<ul style="list-style-type: none"> • F45i • ZIP 250 300 350 • F1 POLAR WHITE 	
	<p>04380-01A Linke Abdeckkappe - <i>LH End Cover</i> - Cache de protection gauche - <i>Cuffia cassonetto Sx</i> Dim./Maße: 170x95x80 mm</p>	<ul style="list-style-type: none"> • F45i L • ZIP 400 450 	
	<p>04381-01A Rechte Abdeckkappe - <i>RH End Cover</i> - Cache de protection droit - <i>Cuffia cassonetto Dx</i> Dim./Maße: 170x125x95 mm</p>	<ul style="list-style-type: none"> • F45i L • ZIP 400 450 	
	<p>04443-01A Linke Abdeckkappe - <i>LH End Cover</i> - Cache de protection gauche - <i>Cuffia cassonetto Sx</i> Dim./Maße: 145x105x85 mm</p>	<ul style="list-style-type: none"> • F65 TOP • Eagle 	
	<p>04444-01A Rechte Abdeckkappe - <i>RH End Cover</i> - Cache de protection droit - <i>Cuffia cassonetto Dx</i> Dim./Maße: 170x110x60 mm</p>	<ul style="list-style-type: none"> • F65 TOP • Eagle 	
	<p>04275-01- Linke Abdeckkappe - <i>LH End Cover</i> - Cache de protection gauche - <i>Cuffia cassonetto Sx</i> Dim./Maße: 140x85x80 mm</p>	<ul style="list-style-type: none"> • F1 	
	<p>04274-01- Rechte Abdeckkappe - <i>RH End Cover</i> - Cache de protection droit - <i>Cuffia cassonetto Dx</i> Dim./Maße: 140x85x80 mm</p>	<ul style="list-style-type: none"> • F1 	





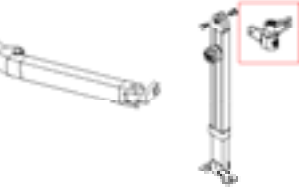









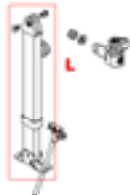

	Nummer/Beschreibung Code/Description - Code/Description - Codice/Descrizione	Für - For Pour - Per	
	<p>04380-01- Linke Abdeckkappe - <i>LH End Cover</i> - Cache de protection gauche - <i>Cuffia cassonetto Sx</i> Dim./Maße: 120x95x80</p>	<ul style="list-style-type: none"> • F1 L 	
	<p>04381-01- Rechte Abdeckkappe - <i>RH End Cover</i> - Embout protecteur droit - <i>Cuffia cassonetto Dx</i> Dim./Maße: 170x125x95 mm</p>	<ul style="list-style-type: none"> • F1 L 	
	<p>02740-01- Linke Abdeckkappe - <i>LH End Cover</i> - Cache de protection gauche - <i>Cuffia cassonetto Sx</i> Dim./Maße: 140x80x50mm</p>	<ul style="list-style-type: none"> • F45 PLUS 	
	<p>02741-01- Rechte Abdeckkappe - <i>RH End Cover</i> - Cache de protection droit - <i>Cuffia cassonetto Dx</i> Dim./Maße: 140x100x80 mm</p>	<ul style="list-style-type: none"> • F45 PLUS 	
	<p>03137-01- Linke Abdeckkappe - <i>LH End Cover</i> - Cache de protection gauche - <i>Cuffia cassonetto Sx</i> Dim./Maße: 160x95x40 mm</p>	<ul style="list-style-type: none"> • F55 PRO • F55 ZIP • F50 ZIP 400 450 	
	<p>03138-01- Rechte Abdeckkappe - <i>RH End Cover</i> - Cache de protection droit - <i>Cuffia cassonetto Dx</i> Dim./Maße: 160x120x100 mm</p>	<ul style="list-style-type: none"> • F55 PRO • F55 ZIP • F50 ZIP 400 450 	
	<p>03073-01- Linke Abdeckkappe - <i>LH End Cover</i> - Cache de protection gauche - <i>Cuffia cassonetto Sx</i> Dim./Maße: 140x80x40 mm</p>	<ul style="list-style-type: none"> • F50 PRO • F50 ZIP 250 300 350 	
	<p>03072-01- Rechte Abdeckkappe - <i>RH End Cover</i> - Cache de protection droit - <i>Cuffia cassonetto Dx</i> Dim./Maße: 160x120x85 mm</p>	<ul style="list-style-type: none"> • F50 PRO • F50 ZIP 250 300 350 	









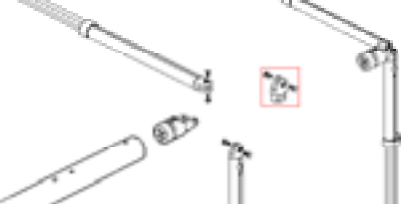



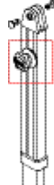

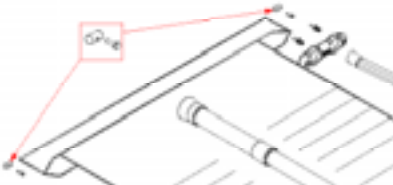

	Nummer/Beschreibung Code/Description - Code/Description - Codice/Descrizione	Für - For Pour - Per	
	<p>98655-178 Linke Abdeckkappe - LH End Cover - Cache de protection gauche - Cuffia cassonetto Sx Dim./Maße: 95x85x25 mm</p>	<ul style="list-style-type: none"> • F45 PLUS L • ELEGANCE XL- L 	
	<p>02520-01- Rechte Abdeckkappe - RH End Cover - Cache de protection droit - Cuffia cassonetto Dx Dim./Maße: 100x95x90 mm</p>	<ul style="list-style-type: none"> • F45 PLUS L • ELEGANCE XL- L 	
	<p>04507-01B Linker Gehäuseverschluss - LH End Cap - Embout gauche - Spalletta cassonetto Sx Dim./Maße: 135x80x35 mm</p>	<ul style="list-style-type: none"> • F45i • ZIP 250 300 350 • F1 POLAR WHITE • fiesta 	
	<p>02771A01B Rechter Gehäuseverschluss - RH End Cap - Embout droit - Spalletta cassonetto Dx Dim./Maße: 135x80x45 mm</p>	<ul style="list-style-type: none"> • F45i • ZIP 250 300 350 • F1 POLAR WHITE • fiesta 	
	<p>04386-01A Linker Gehäuseverschluss - LH End Cap - Embout gauche - Spalletta cassonetto Sx Dim./Maße: 160x90x50 mm</p>	<ul style="list-style-type: none"> • F45i L • ZIP 400 450 	
	<p>04507-01- Linker Gehäuseverschluss - LH End Cap - Embout gauche - Spalletta cassonetto Sx Dim./Maße: 135x80x45 mm</p>	<ul style="list-style-type: none"> • F1 	
	<p>04386-01- Linker Gehäuseverschluss - LH End Cap - Embout gauche - Spalletta cassonetto Sx Dim./Maße: 160x90x50 mm</p>	<ul style="list-style-type: none"> • F1 L 	
	<p>02771-01- Linker Gehäuseverschluss - LH End Cap - Embout gauche - Spalletta cassonetto Sx Dim./Maße: 150x80x35 mm</p>	<ul style="list-style-type: none"> • F45 PLUS • F50 PRO • F50 ZIP 250 300 350 	

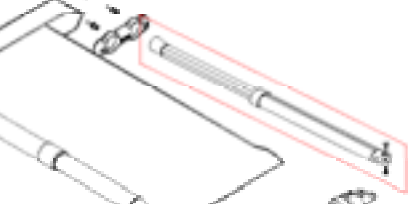

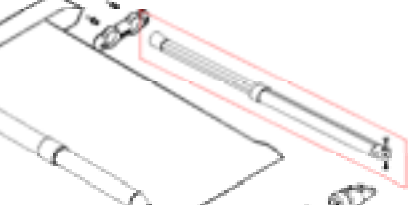





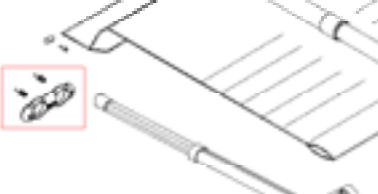



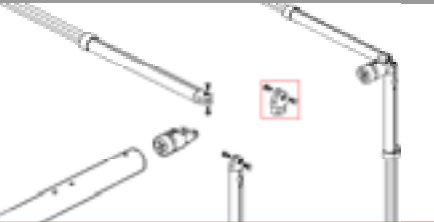

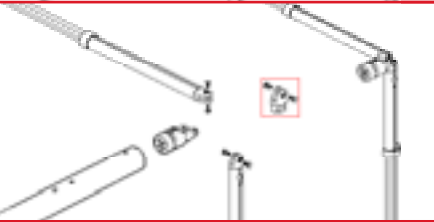
	Nummer/Beschreibung Code/Description - Code/Description - Codice/Descrizione	Für - For Pour - Per	
	<p>02771A01- Rechter Gehäuseverschluss - RH End Cap - Embout droit - Spalletta cassonetto Dx Dim./Maße: 135x80x45 mm</p>	<ul style="list-style-type: none"> • F45 PLUS • F1 • F50 PRO • F50 ZIP 250 300 350 	
	<p>02595-01- Linker Gehäuseverschluss - LH End Cap - Embout gauche - Spalletta cassonetto Sx Dim./Maße: 155x95x30 mm</p>	<ul style="list-style-type: none"> • F45 PLUS L 	
	<p>02595A01- Rechter Gehäuseverschluss - RH End Cap - Embout droit - Spalletta cassonetto Dx Dim./Maße: 155x90x40 mm</p>	<ul style="list-style-type: none"> • F45 PLUS L 	
	<p>03278-01- Linker Gehäuseverschluss - LH End Cap - Embout gauche - Spalletta cassonetto Sx Dim./Maße: 155x90x40 mm</p>	<ul style="list-style-type: none"> • F55 PRO • F50 ZIP 400 450 	
	<p>03278A01- Rechter Gehäuseverschluss - RH End Cap - Embout droit - Spalletta cassonetto Dx Dim./Maße: 155x90x50 mm</p>	<ul style="list-style-type: none"> • F1 L • F55 PRO • F50 ZIP 400 450 	
	<p>04273-01C Linker Frontblendenverschluss LH Front End Cap Crochetage gauche Spalletta frontale Sx</p>	<ul style="list-style-type: none"> • F45i • ZIP 250 300 350 • F1 POLAR WHITE • fiesta 	
	<p>04273A01C Rechter Frontblendenverschluss RH Front End Cap Crochetage droit Spalletta frontale Dx</p>	<ul style="list-style-type: none"> • F45i • ZIP 250 300 350 • F1 POLAR WHITE • fiesta 	
	<p>04384-01A Linker Frontblendenverschluss LH Front End Cap Crochetage gauche Spalletta frontale Sx</p>	<ul style="list-style-type: none"> • F45i L • ZIP 400 450 	

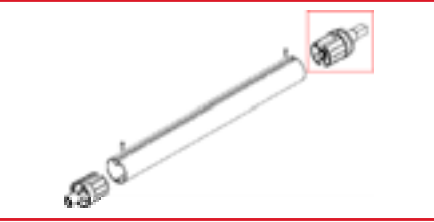
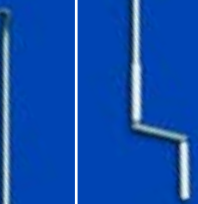

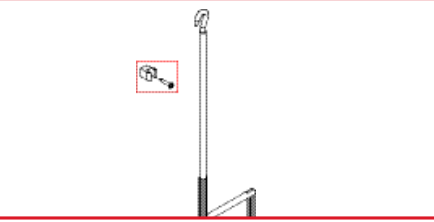

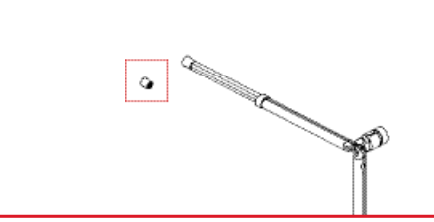







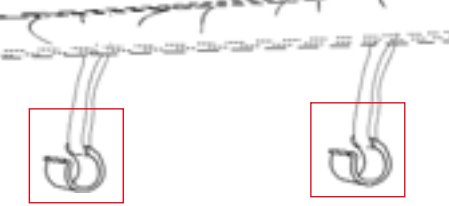

	Nummer/Beschreibung Code/Description - Code/Description - Codice/Descrizione	Für - For Pour - Per	
	<p>04384A01A Rechter Frontblendenverschluss <i>RH Front End Cap</i> Crochetage droit <i>Spalletta frontale Dx</i></p>	<ul style="list-style-type: none"> • F45i L • ZIP 400 450 	
	<p>04445-01A Linker Frontblendenverschluss <i>LH Front End Cap</i> Crochetage gauche <i>Spalletta frontale Sx</i></p>	<ul style="list-style-type: none"> • F65 TOP • F65 TOP 04 • Eagle 	
	<p>04446-01A Rechter Frontblendenverschluss <i>RH Front End Cap</i> Crochetage droit <i>Spalletta frontale Dx</i></p>	<ul style="list-style-type: none"> • F65 TOP • F65 TOP 04 • Eagle 	
	<p>04273-01- Linker Frontblendenverschluss <i>LH Front End Cap</i> Crochetage gauche <i>Spalletta frontale Sx</i></p>	<ul style="list-style-type: none"> • F1 	
	<p>04273A01- Rechter Frontblendenverschluss <i>RH Front End Cap</i> Crochetage droit <i>Spalletta frontale Dx</i></p>	<ul style="list-style-type: none"> • F1 	
	<p>02739-01- Linker Frontblendenverschluss <i>LH Front End Cap</i> Crochetage gauche <i>Spalletta frontale Sx</i></p>	<ul style="list-style-type: none"> • F45 PLUS • F50 PRO 	
	<p>02739A01- Rechter Frontblendenverschluss <i>RH Front End Cap</i> Crochetage droit <i>Spalletta frontale Dx</i></p>	<ul style="list-style-type: none"> • F45 PLUS • F50 PRO 	
	<p>03136-01- Linker Frontblendenverschluss <i>LH Front End Cap</i> Crochetage gauche <i>Spalletta frontale Sx</i></p>	<ul style="list-style-type: none"> • F45 PLUS L • F55 PRO • F50 ZIP 400 450 	

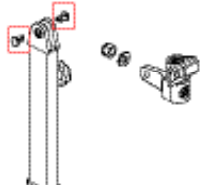

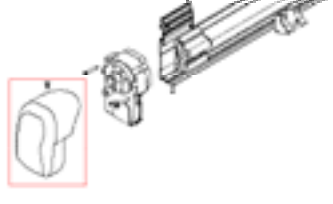

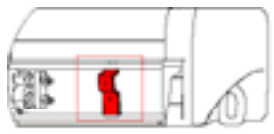
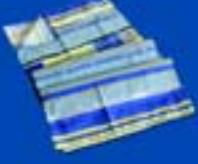
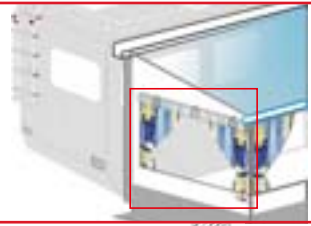

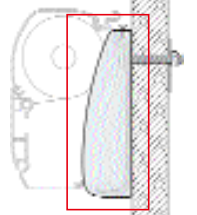

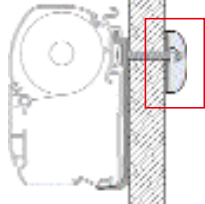
	Nummer/Beschreibung Code/Description - Code/Description - Codice/Descrizione	Für - For Pour - Per	
	<p>03136A01- Rechter Frontblendenverschluss <i>RH Front End Cap</i> Crochetage droit <i>Spalletta frontale Dx</i></p>	<ul style="list-style-type: none"> • F45 PLUS L • F55 PRO • F50 ZIP 400 450 	
	<p>02706-03A Rechtes Stützfußgelenk <i>RH Leg Joint</i> Articulation de pied droite <i>Snodo palina Dx</i></p>	<ul style="list-style-type: none"> • F45i • F1 Titanium • ZIP 250 300 350 	
	<p>02706-03- Linkes Stützfußgelenk <i>LH Leg Joint</i> Articulation de pied gauche <i>Snodo palina Sx</i></p>	<ul style="list-style-type: none"> • F45i • F1 Titanium • ZIP 250 300 350 	
	<p>02707-03A Rechtes Stützfußgelenk <i>RH Leg Joint</i> Articulation de pied droit <i>Snodo palina Dx</i></p>	<ul style="list-style-type: none"> • F45i L • ZIP 400 450 • F1 L Titanium • F65 TOP 	
	<p>02707-03- Linkes Stützfußgelenk <i>LH Leg Joint</i> Articulation de pied gauche <i>Snodo palina Sx</i></p>	<ul style="list-style-type: none"> • F45i L • ZIP 400 450 • F1 L Titanium • F65 TOP 	
	<p>02706-01A Rechtes Stützfußgelenk <i>RH Leg Joint</i> Articulation de pied droit <i>Snodo palina Dx</i></p>	<ul style="list-style-type: none"> • F1 • F45 PLUS • F50 PRO • F50 ZIP 250 300 350 • F60 TOP 	
	<p>02706-01- Linkes Stützfußgelenk <i>LH Leg Joint</i> Articulation de pied gauche <i>Snodo palina Sx</i></p>	<ul style="list-style-type: none"> • F1 • F45 PLUS • F50 PRO • F50 ZIP 250 300 350 • F60 TOP 	
	<p>02707-01A Rechtes Stützfußgelenk <i>RH Leg Joint</i> Articulation de pied droit <i>Snodo palina Dx</i></p>	<ul style="list-style-type: none"> • F45i L • F1 L • F45 PLUS L • F55 PRO • F50 ZIP 400 450 	

		Für - For Pour - Per	
	<p>02707-01- Linkes Stützfußgelenk <i>LH Leg Joint</i> Articulation de pied gauche <i>Snodo palina Sx</i></p>	<ul style="list-style-type: none"> • F45i L • F1 L • F45 PLUS L • F55 PRO • F50 ZIP 400 450 	
	<p>04437-03A Rechter Stützfuß <i>RH Leg</i> Pied droit <i>Palina Dx</i></p>	<ul style="list-style-type: none"> • ELEGANCE XL 350 400 • F50 350 • F55 400 • F45 PLUS 350 400 • F45 PLUS L 400 • F1 350 400 • F1 L 400 • F45i 350 (S/N < 9331712) 	
	<p>04437-03- Linker Stützfuß <i>LH Leg</i> Pied gauche <i>Palina Sx</i></p>	<ul style="list-style-type: none"> • ELEGANCE XL 350 400 • F50 350 • F55 400 • F45 PLUS 350 400 • F45 PLUS L 400 • F1 350 400 • F1 L 400 • F45i 350 (S/N < 9331712) 	
	<p>98655-171 Kit Stützfußverriegelung <i>Leg Blocking Kit</i> Kit blocage pied <i>Kit bloccaggio palina</i></p>	<ul style="list-style-type: none"> • CARAVASTORE 05 • CARAVASTORE 04 • CARAVASTORE ZIP • F35 PRO • 35 ZIP 	
	<p>98655-170 Kit Stützfußverriegelung <i>Leg Blocking Kit</i> Kit blocage pied <i>Kit bloccaggio palina</i></p>	<ul style="list-style-type: none"> • F45 PLUS • F35 PRO • F50 • CARAVANSTOR • F60 TOP 	
	<p>98655-160 Kit Stützfußendstück - Leg End <i>Part Kit - Embout de pied - Kit terminale palina</i> Ø 30x20 mm</p>	<ul style="list-style-type: none"> • F45i L • ZIP 400 450 • F1 L • F45 PLUS L • F50 • F55 • ELEGANCE XL-L 	
	<p>98655-158 Kit Stützfußendstück - Leg End <i>Part Kit - Embout de pied - Kit terminale palina</i> Ø 27x15 mm</p>	<ul style="list-style-type: none"> • F45i • F65 TOP • ZIP 250 300 350 • F1 • F45 PLUS • F60 TOP • F50 • ELEGANCE XL-S 	
	<p>98655-214 Kit Stützfußendstück <i>Leg End Part Kit</i> Embout de pied <i>Kit terminale palina</i></p>	<ul style="list-style-type: none"> • CARAVANSTORE • F35 	

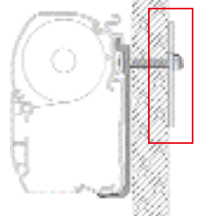

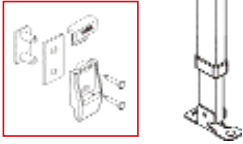

	Nummer/Beschreibung Code/Description - Code/Description - Codice/Descrizione	Für - For Pour - Per	
	98655-452 Kit Verriegelungsschraube <i>Leg Handwheel Kit</i> Molette de blocage Kit volante palina	<ul style="list-style-type: none"> • Alle/All/Tous/Tutti 	
	98655-150 Kit Stützfußgestänge <i>Tie Rod Kit</i> Kit tenseur Kit tiranti paline	<ul style="list-style-type: none"> • F35 PRO 	
	98655-186 Kit Sperrzahn <i>Pawls Kit</i> Vis de sécurité Kit nottolini	<ul style="list-style-type: none"> • CARAVANSTORE 05 • CARAVANSTORE 04 • CARAVANSTORE 02 • CARAVANSTORE • CARAVANSTORE ZIP 	
	03567C03- Spannstange Tension Rafter Rafter, tendeur de toile Rafter - Asta di tensione	<ul style="list-style-type: none"> • CARAVANSTORE 04 280 310 360 400 440 	
	03567A01- Spannstange Tension Rafter Rafter, tendeur de toile Rafter - Asta di tensione	<ul style="list-style-type: none"> • CARAVANSTORE 280 310 360 400 	
	04151C01- Rafter Endstück <i>Rafter End Part</i> Partie finale tendeur de toile Terminale rafter	<ul style="list-style-type: none"> • CARAVANSTORE 280 310 360 400 	
	98655-192 Kit Rafterstütze <i>Rafter Wall Support Kit</i> Kit appui paroi Kit appoggio parete	<ul style="list-style-type: none"> • CARAVANSTORE • CARAVANSTORE 02 	
	98655-707 Kit Rafterstütze <i>Rafter wall Support Kit</i> Kit appui paroi Kit appoggio parete	<ul style="list-style-type: none"> • CARAVANSTORE 05 • CARAVANSTORE ZIP • CARAVANSTORE 04 	







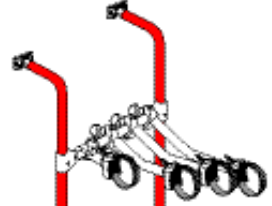

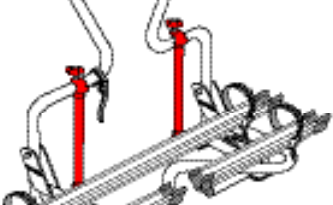





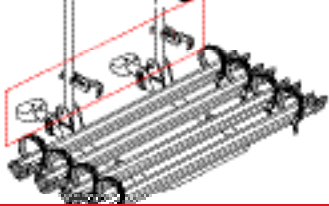

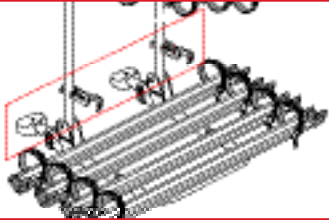
	Nummer/Beschreibung Code/Description - Code/Description - Codice/Descrizione	Für - For Pour - Per	
	98655-217 Kit Stützfußendstück <i>Leg End Part Kit</i> Embout de pied <i>Kit terminale palina</i>	<ul style="list-style-type: none"> • CARAVANSTORE 05 • F35 PRO • CARAVANSTORE ZIP • 35 ZIP 	
	98655-215 Kit Stützfußendstück <i>Leg End Part Kit</i> Embout de pied <i>Kit terminale palina</i>	<ul style="list-style-type: none"> • CARAVANSTORE 05 • F35 PRO • CARAVANSTORE ZIP • 35 ZIP 	
	03308-01- Endanschlagsvorrichtung <i>Roller Tube End Cap</i> Axe d'entraînement - <i>Fine corsa</i> ø 48 mm	<ul style="list-style-type: none"> • F45i (S/N < 9331712) • F1 • F45 PLUS 	
	04660-01- Handkurbel <i>Crank Handle</i> Manivelle <i>Asta di manovra</i>	<ul style="list-style-type: none"> • Alle/All/Tous/Tutti 	
	98655-095 Kit Handkurbelhalterung - <i>Crank Handle Support Kit</i> - Kit attache paroi manivelle - <i>Kit Aggancio a parete per asta di manovra</i> ø 12 mm	<ul style="list-style-type: none"> • Alle/All/Tous/Tutti 	
	97733-035 Stützfußschutz - <i>Rubber Cap</i> - Protection de pied - <i>Sottopiede</i> ø 16 mm	<ul style="list-style-type: none"> • CARAVANSTORE • CARAVANSTORE 02 • CARAVANSTORE 04 • CARAVANSTORE 05 • CARAVANSTORE ZIP • F35 	
	97733-038 Stützfußschutz - <i>Rubber Cap</i> - Protection de pied - <i>Sottopiede</i> ø 20 mm	<ul style="list-style-type: none"> • CARAVANSTORE • CARAVANSTORE 02 • CARAVANSTORE 04 • CARAVANSTORE 05 • CARAVANSTORE ZIP 	
	03458-01- Antirutschgummi <i>Non-slip Rubber Cap</i> Caoutchouc antidérapant <i>Gommino antisdrucciolo</i>	<ul style="list-style-type: none"> • Alle/All/Tous/Tutti 	

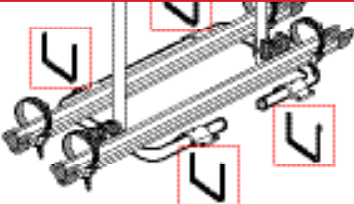

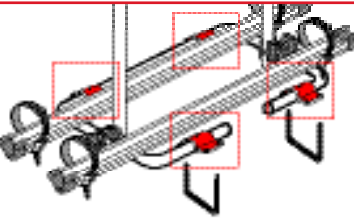

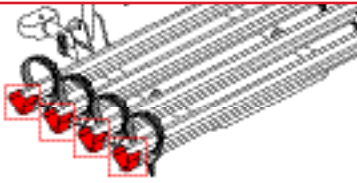



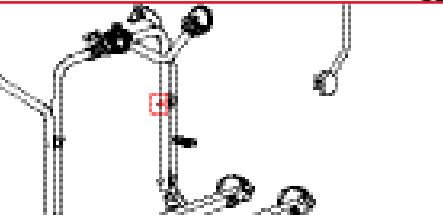



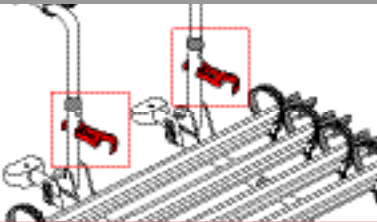

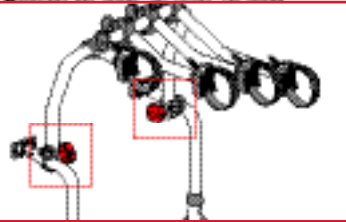
	Nummer/Beschreibung Code/Description - Code/Description - Codice/Descrizione	Für - For Pour - Per	
	98655-065 Montage Kit für Rapid Set <i>Rapid Set Fixing Kit</i> Kit fixation Rapid Set <i>Kit fissaggio Rapid Set frontale</i>	<ul style="list-style-type: none"> • PRIVACY 	
	98655-344 Kit Haken Privacy <i>Privacy Hook Kit</i> Kit crochet privacy <i>Kit gancio privacy</i>	<ul style="list-style-type: none"> • PRIVACY 	
	92540-015 Snip-Snap Niete <i>Snip-Snap Rivet</i> Rivet Snip-Snap <i>Rivetto Snip-Snap</i>	<ul style="list-style-type: none"> • Alle/All/Tous/Tutti 	
	92509-005 Druckknopf <i>Clip</i> Bouton à pression <i>Bottone a pressione</i>	<ul style="list-style-type: none"> • Alle/All/Tous/Tutti 	
	98655-071 Slip Rapid Set <i>Rapid Set Clip</i> Clip Rapid Set <i>Clip Rapid Set</i>	<ul style="list-style-type: none"> • PRIVACY 	
	03671B01- Gardinen <i>Curtains</i> Rideaux <i>Tendine</i>	<ul style="list-style-type: none"> • PRIVACY ROOM • FIAMMA ZIP • PRIVACY ROOM CS • CARAVANSTORE ZIP • FIAMMA 35 ZIP 	
	98655-678 Kit Cover Adapter 120 (3x) Äußeren Plastikabdeckungen - <i>External covers in plastic material -</i> Couvercles extérieurs en matière plastique - <i>Copertura esterne</i> in materiale plastico	<ul style="list-style-type: none"> • AWNINGS 	
	98656-276 Cover Plate (2x) Inneren Plastikabdeckungen - <i>Internal bracket cover -</i> Couvercles intérieurs en matière plastique - <i>Copertura interne</i> in materiale plastico	<ul style="list-style-type: none"> • AWNINGS 	

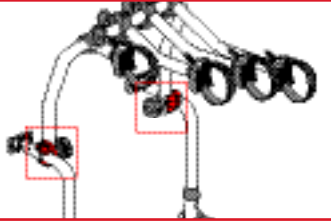
	Nummer/Beschreibung Code/Description - Code/Description - Codice/Descrizione	Für - For Pour - Per	
	98656-275 Plate XL (2x) Innenplatten aus Aluminium - <i>Internal bracket cover - Plaques de renfort intérieur en aluminium - Piastre interne di rinforzo in alluminio</i>	<ul style="list-style-type: none"> • AWNINGS 	
	98655-176 Wandhalterung für die Stützfüsse <i>Plastic wall mounting brackets</i> Kit pattes de fixation en plastique <i>Kit attacco a parete in plastica</i>	<ul style="list-style-type: none"> • AWNINGS 	
	98655-728 Wandhalterung aus glänzendem Aluminium - <i>Aluminium wall mounting brackets - Kit pattes de fixation à parois en aluminium - Kit attacco a parete in alluminio</i>	<ul style="list-style-type: none"> • AWNINGS 	
	05255-01- Awning Paint Spray - Polar Lack zum Retuschieren <i>Spray paint to retouch</i> Vernis en spray pour retouches <i>Vernice spray per ritocchi</i>	<ul style="list-style-type: none"> • AWNINGS 	
	98655-735 Awning Paint Pencil - Polar Lack zum Retuschieren <i>Paint to retouch</i> Vernis pour retouches <i>Vernice per ritocchi</i>	<ul style="list-style-type: none"> • AWNINGS 	

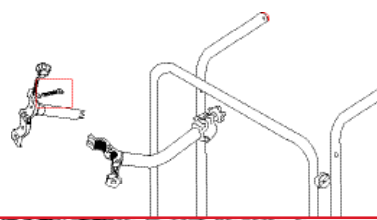

Carry-Bike

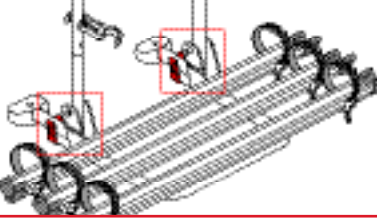
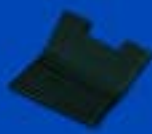
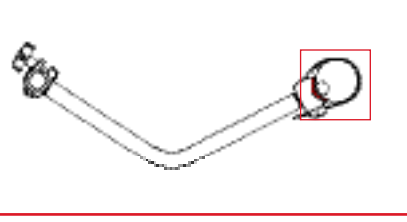

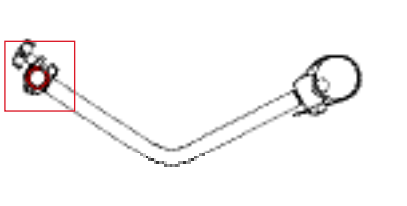









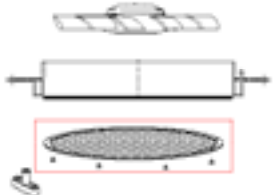

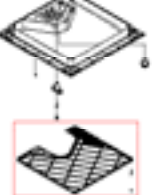

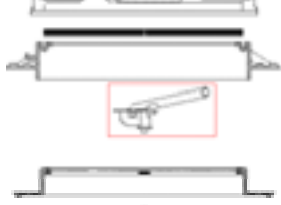
	Nummer/Beschreibung Code/Description - Code/Description - Codice/Descrizione	Für - For Pour - Per	
	98656-268 Kit Obere Struktur <i>Upper Structure Kit</i> Kit structure supérieure <i>Kit struttura superiore</i>	<ul style="list-style-type: none"> • PRO • PRO MAX • PLUS • PRO D 	
	04530-01- Kit verstärkte Struktur <i>Structure Reinforcement</i> Kit renfort de structure <i>Kit rinforzo struttura</i>	<ul style="list-style-type: none"> • CARAVAN XLA PRO 	

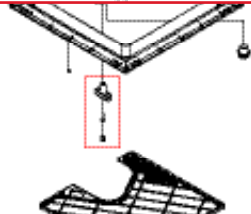

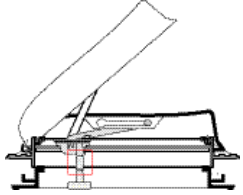

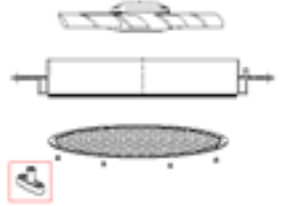
	Nummer/Beschreibung Code/Description - Code/Description - Codice/Descrizione	Für - For Pour - Per	
	98656-588 Kit Obere Befestigungen - <i>Upper Brackets Kit</i> - Kit attaches supérieures - <i>Kit agganci superiori</i> 4x M6X50 Schrauben/ <i>Screws / Vis / Viti</i>	<ul style="list-style-type: none"> • PRO • PRO C • PLUS • PLUS C • CL • UL • 2000 • LIFT 77 	
	98656-005 Kit Untere Befestigungen - <i>Lower Brackets Kit</i> - Kit attaches inférieures - <i>Kit agganci inferiori</i> 4x M6X50 Schrauben / <i>Screws / Vis / Viti</i>	<ul style="list-style-type: none"> • PRO • PRO C • UL • CL 	
	98656-220 Kit Untere Befestigungen - <i>Lower Brackets Kit</i> - Kit attaches inférieures - <i>Kit agganci inferiori</i> 4x M6X65 Schrauben / <i>Screws / Vis / Viti</i>	<ul style="list-style-type: none"> • PRO • PRO C • UL • CL 	
	02605-01- Bügelschraube <i>M6 Staple</i> U de fixation <i>Cavallotto M6</i>	<ul style="list-style-type: none"> • CARAVAN XLA 	
	02604-01- Befestigung 70 mm <i>70 mm Fixing Bracket</i> Etrier de fixation 70 mm <i>Staffa di fissaggio 70 mm</i>	<ul style="list-style-type: none"> • CARAVAN XLA • GARAGE PLUS 	
	04574-01- Schienenkappe <i>End Cap</i> Embout de rail <i>Tappo canalina</i>	<ul style="list-style-type: none"> • Alle/All/Tous/Tutti 	
	98656-206 Kit Schieber <i>Sliders Kit</i> Kit coulissant <i>Kit scorrevoli</i>	<ul style="list-style-type: none"> • 200 D • PRO D • GARAGE • RENAULT TRAFIC • VW T5 • 300 DB • CARAVAN XLA • 4x4 	
	02972-01- Mutterabdeckung M6 <i>M6 Nut Cap</i> Couvre-écrou M6 <i>Copridado M6</i>	<ul style="list-style-type: none"> • Alle/All/Tous/Tutti 	

	Nummer/Beschreibung Code/Description - Code/Description - Codice/Descrizione	For - Für Pour - Per	
	<p>98656-378 Rack Holder</p>	<ul style="list-style-type: none"> • Alle/All/Tous/Tutti 	
	<p>98656-290 Schraubverschluss Handwheel Kit Kit manivelle Kit volante</p>	<ul style="list-style-type: none"> • CL • PROC • PLUS • VW T2 • CV • RENAULT TRAFIC • GARAGE PLUS • CARAVAN XLA • BACKPACK • 4x4 	
	<p>03034A01- Zahnrad - Toothed Joint - Rondelle dentelée - Rosetta dentata ø 30 mm</p>	<ul style="list-style-type: none"> • CL • PROC • PLUS • VW T2 • CV • RENAULT TRAFIC • GARAGE PLUS • CARAVAN XLA • BACKPACK • 4x4 	
	<p>02564-01- T Schraube M6 - T shaped M6 Screw - Vis M6 a T - Vite M6 a T</p>	<ul style="list-style-type: none"> • BIKE BLOCK • PRO D • 300 DB 	
	<p>98656-292 Kit Unterstütze - Foot Kit - Kit pied de soutien - Kit piedino ø 32 mm</p>	<ul style="list-style-type: none"> • MERCEDES VITO • VW SHARAN • OPEL VIVARO • RENAULT TRAFIC • VW T4 	
	<p>02206-01- Zwinge Clamp Support Morsetto a scatto</p>	<ul style="list-style-type: none"> • CL • UL • VW T3 • TRIGANO 	
	<p>04142-01- Gummidichtung Side Rubbing Strip Protection en caoutchouc Protezione in gomma</p>	<ul style="list-style-type: none"> • BIKE BLOCK PRO 	
	<p>05099-01- Innenring Bike-Block Reduction Reduction Bike-Block Riduzione Bike-Block</p>	<ul style="list-style-type: none"> • BIKE BLOCK PRO 	











	Nummer/Beschreibung Code/Description - Code/Description - Codice/Descrizione	Für - For Pour - Per	
	98656-010 Verlängerungen aus Aluminium <i>Extension rods in aluminium</i> Rallonges en aluminium <i>Prolunghe in alluminio</i>	<ul style="list-style-type: none"> • CARRY-BIKE UL 	
	02867-01A Adapter zum Anpassen <i>Reduction kit</i> Kit de réduction <i>Kit riduzione</i>	<ul style="list-style-type: none"> • RAIL CARRY-BIKE 	
	98656-034 Puffer <i>Protection pads</i> Protections en mousse épaisse <i>Paracolpi</i>	<ul style="list-style-type: none"> • CARRY-BIKE 	
	98656-275 Innenplatten aus Aluminium <i>Internal bracket cover</i> Plaques de renfort en aluminium <i>Piastre interne di rinforzo in alluminio</i>	<ul style="list-style-type: none"> • CARRY-BIKE 	
	98656-276 Äußeren Plastik-abdeckungen - <i>Internal bracket cover -</i> Couvercles extérieurs en matière plastique - <i>Coperture interne</i> <i>in materiale plastico</i>	<ul style="list-style-type: none"> • CARRY-BIKE 	
	98656-419 Riemen 200 cm lang <i>Strip 200 cm long</i> Sangle de 200cm de longueur <i>Cinghia lunga 200cm.</i>	<ul style="list-style-type: none"> • CARRY-BIKE 	







			
	<p>04598-01- Weiße Haube <i>White Cover</i> Couvercle blanc <i>Coperchio bianco</i></p>	<ul style="list-style-type: none"> • TURBO-VENT • TURBO-VENT P3 • VENT • TURBO-VENT 160 • TURBO-VENT 160 P3 • VENT 160 	
	<p>04598-01D (2006) Crystal Haube <i>Crystal Cover</i> Couvercle Crystal <i>Coperchio Crystal</i></p>	<ul style="list-style-type: none"> • TURBO-VENT • TURBO-VENT P3 • VENT • TURBO-VENT 160 • TURBO-VENT 160 P3 • VENT 160 	
	<p>00533B01- Weiße Haube <i>White Cover</i> Couvercle blanc <i>Coperchio bianco</i></p>	<ul style="list-style-type: none"> • TURBO-VENT 1500 • TURBO-VENT PRO • VENT 40x40 	
	<p>00533B01D Crystal Haube <i>Crystal Cover</i> Couvercle crystal <i>Coperchio crystal</i></p>	<ul style="list-style-type: none"> • TURBO-VENT 1500 • TURBO-VENT PRO • VENT 40x40 	
	<p>00533B01C Fumé Haube <i>Fumé Cover</i> Couvercle fumé <i>Coperchio Fumé</i></p>	<ul style="list-style-type: none"> • TURBO-VENT 1500 • TURBO-VENT PRO • VENT 40x40 	
	<p>04922-01- Weiße Haube <i>White Cover</i> Couvercle blanc <i>Coperchio bianco</i></p>	<ul style="list-style-type: none"> • VENT 28 • TURBO 28 	
	<p>04922-01A Crystal Haube <i>Crystal Cover</i> Couvercle crystal <i>Coperchio crystal</i></p>	<ul style="list-style-type: none"> • VENT 28 • TURBO 28 	
	<p>04779-01- Gitter <i>Grid</i> Grille <i>Griglia</i></p>	<ul style="list-style-type: none"> • TURBO-VENT • TURBO-VENT P3 • TURBO-VENT 160 • TURBO-VENT 160 P3 	

	Nummer/Beschreibung Code/Description - Code/Description - Codice/Descrizione	For - Für Pour - Per	
	03646A01- Gitter Grid Grille Griglia	<ul style="list-style-type: none"> • TURBO-VENT PRO 	
	03689-01- Gitter Grid Grille Griglia	<ul style="list-style-type: none"> • VENT 160 • TURBO-VENT 1 • TURBO-VENT 1500 	
	00741B01- Öffnungsmechanismus Opening Mechanism Mécanisme d'ouverture Dispositivo d'apertura	<ul style="list-style-type: none"> • TURBO-VENT • TURBO-VENT P3 • TURBO-VENT 160 • TURBO-VENT 160 P3 • TURBO-VENT 1 • TURBO-VENT PRO • VENT 160 	
	98683-050 Öffnungsschraube Handwheel Kit Kit manivelle Kit volantino	<ul style="list-style-type: none"> • VENT 160 • TURBO-VENT 1 • TURBO-VENT 1500 • MOTOR-VENT • VENT 40x40 	
	98683-018 Extension Kit	<ul style="list-style-type: none"> • VENT 160 • TURBO-VENT 1 • MOTORVENT • VENT 40x40 	
	03863A01- Öffnungsschraube - Handwheel Kit - Kit manivelle - Kit volantino	<ul style="list-style-type: none"> • TURBO-VENT • VENT • VENT 28 • TURBO 28 • TURBO-VENT 160 • TURBO-VENT 160 P3 • TURBO-VENT PRO 	
	98683-112 Universelles Handgriff- und Verlängerungskit Kit de manivelles et rallonges universelles - Universal knobs and extension kit Kit di volantini e prolungh universali	<ul style="list-style-type: none"> • TURBO-VENT • VENT • VENT 28 • TURBO 28 • TURBO-VENT 160 • TURBO-VENT 160 P3 • TURBO-VENT PRO 	 <p>4.5 + 8.5 cm</p>
	98683-113 PVC Roller Collar in PVC Collier en PVC Collare in PVC	<ul style="list-style-type: none"> • TURBO-VENT • TURBO-VENT 160 • TURBO-VENT PRO 	







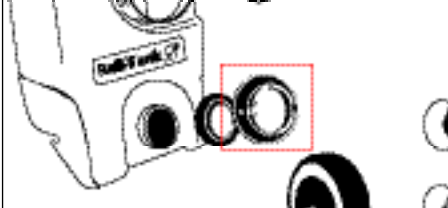

	Nummer/Beschreibung <i>Code/Description -</i> <i>Code/Description - Codice/Descrizione</i>	For - Für Pour - Per	
	95170-026 Platine <i>Electronic Plate</i> Fiche électronique <i>Scheda elettronica</i>	<ul style="list-style-type: none"> • TURBO-VENT 160 P3 • TURBO-VENT P3 	
	95170-020 Platine <i>Electronic Plate</i> Fiche électronique <i>Scheda elettronica</i>	<ul style="list-style-type: none"> • TURBO-VENT • TURBO-VENT 160 • TURBO-VENT PRO 	





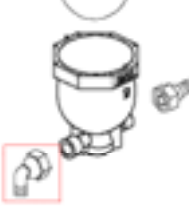

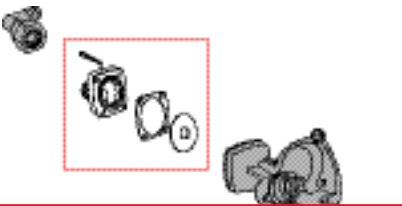
Bi-Pot

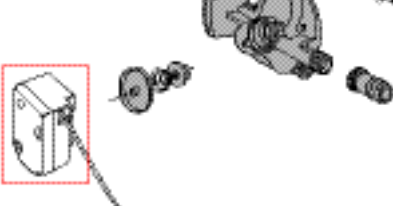
	Nummer/Beschreibung <i>Code/Description -</i> <i>Code/Description - Codice/Descrizione</i>	For - Für Pour - Per	
	00925A01C Verbindungsgriff <i>Fixing Joint</i> Charnière d'accroche <i>Cerniera di aggancio</i>	<ul style="list-style-type: none"> • Alle/All/Tous/Tutti 	
	00923A01E Kit Pumpe <i>Pump Kit</i> Kit pompe <i>Kit pompa</i>	<ul style="list-style-type: none"> • Alle/All/Tous/Tutti 	
	00781A01B Deckel + Deckeldichtung <i>WC Cap + Gasket</i> Bouchon WC + joint <i>Tappo WC + guarnizione</i>	<ul style="list-style-type: none"> • Alle/All/Tous/Tutti 	
	00782A01- Deckeldichtung <i>Cap Gasket</i> Joint bouchon <i>Guarnizione tappo</i> ø 80 mm	<ul style="list-style-type: none"> • Alle/All/Tous/Tutti 	
	01879-01- Obere Dichtung <i>Upper Gasket</i> Joint supérieur <i>Guarnizione superiore</i> ø 100 mm	<ul style="list-style-type: none"> • Alle/All/Tous/Tutti 	







	Nummer/Beschreibung Code/Description - Code/Description - Codice/Descrizione	For - Für Pour - Per	
	01455-01- Untere Dichtung Lower Gasket Joint inférieur Guarnizione inferiore ø 95 mm	<ul style="list-style-type: none"> • Alle/All/Tous/Tutti 	
	02397C01- Deckel 3" 3" Cap Bouchon 3" Tappo 3"	<ul style="list-style-type: none"> • TANK 18 • TANK 21 • TANK 40 • ROLL 	
	01803-01- Plansch Flange Raccord Flangia	<ul style="list-style-type: none"> • TANK 18 • TANK 21 • TANK 40 • ROLL 	



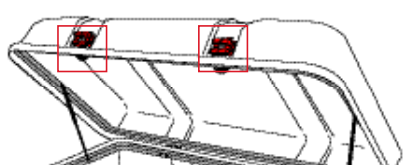

Aqua8

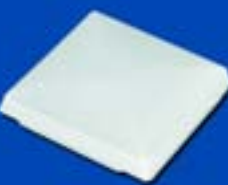
	Nummer/Beschreibung Code/Description - Code/Description - Codice/Descrizione	For - Für Pour - Per	
	01476C01- Gerade Gummihalter Straight adapter Raccord droit Portagomma dritto ø 13 mm	<ul style="list-style-type: none"> • AQUA 8 • SF 126 	
	01476-01- Winkelgummihalter Elbow adapter Raccord à L Portagomma a L ø 13 mm	<ul style="list-style-type: none"> • AQUA 8 • SF 126 	
	01203C01- Kit Filter Filter Kit Kit filtre Kit filtro	<ul style="list-style-type: none"> • AQUA 8 • SF 126 	
	01203B02- Kit Druckshalter Pressure Switch Kit Kit Pressostat Kit pressostato	<ul style="list-style-type: none"> • AQUA 8 • SF 126 	

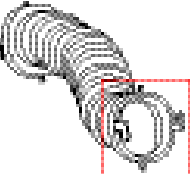
	Nummer/Beschreibung <i>Code/Description -</i> <i>Code/Description - Codice/Descrizione</i>	For - Für Pour - Per	
	01200-02- Kit Ventile <i>Valves Kit</i> Kit Valve <i>Kit valvole</i>	<ul style="list-style-type: none"> • AQUA 8 • SF 126 	
	01199A01- Kit Diaphragma <i>Diaphragme Kit</i> Kit Diaphragme <i>Kit Diaframma</i>	<ul style="list-style-type: none"> • AQUA 8 • SF 126 	
	98657-015 Kit Upgrade	<ul style="list-style-type: none"> • AQUA 8 • SF 126 PRO • S20 • S12 NEW 	

Verschiedenes/Miscellaneous/Autres/Varie

	Nummer/Beschreibung <i>Code/Description -</i> <i>Code/Description - Codice/Descrizione</i>	For - Für Pour - Per	
	02705B01- Handgriff <i>Handle</i> Poignée <i>Maniglia</i>	<ul style="list-style-type: none"> • ULTRA-BOX 1 • ULTRA-BOX 2 • ULTRA-BOX 3 • ULTRA-BOX SPORT 	
	94712-010 Wassertankverschluss <i>Water Tank Cap</i> Bouchon réservoir eau <i>Tappo serbatoio acqua</i>	<ul style="list-style-type: none"> • WATER CAP 	
	00770-01- Lichtkappe <i>Roof lamp protection</i> Protection lumière <i>Protezione luci</i> Dim./Maße: 125x125x20 mm	<ul style="list-style-type: none"> • L1 • L2 • L1 1/2 	
	02397E01- Gerade Abwasseranschluß <i>Straight adapter</i> Raccord droit <i>Raccordo dritto</i>	<ul style="list-style-type: none"> • SANITARY-FLEX KIT 75 	

	Nummer/Beschreibung <i>Code/Description -</i> Code/Description - <i>Codice/Descrizione</i>	For - Für Pour - Per	
	04663-01A Door Holder	<ul style="list-style-type: none"> • Alle/All/Tous/Tutti 	
	98655-181 Kit Saugnäpfe <i>Sunctions cups</i> Kit ventouses <i>Kit ventose</i>	<ul style="list-style-type: none"> • Thermoglas 	

Note